



Doosan Infracore  
Construction Equipment

# DX350LC

Engine Power : SAE J1349, net 202kW(271HP)@1,900rpm

Operational Weight : 35,200kg(77,602 lb) - STD.

Bucket capacity(SAE) : 1.25 ~ 1.83m<sup>3</sup>(1.64 ~ 2.39 cu.yd)

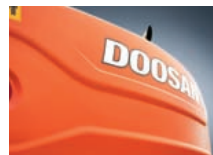

Photo may include optional equipment



# DX350LC

The new DX350LC hydraulic excavator has all the advantages of the previous model, and now offers additional added value to the operator.



The new DX350LC was developed with the concept of "providing optimum value to the end user." In concrete terms, this translates, into :

# Doosan DX350LC Hydraulic Excavator : A New Model with Novel Features



**Increased production** and improved fuel economy is attributed to the electronic optimization of the hydraulic system and the new generation DOOSAN engine (Tier III).

**Improved ergonomics**, increases comfort and excellent all round visibility ensuring a safe and pleasant working environment.

**Improved reliability** is achieved through the use of high performance materials combined with new methods of structural stress analysis, and leads to increased component life expectancy, thus reducing running costs.

**Reduced maintenance** increases the availability and reduces operating costs of the excavator.

# Handling

## DX350LC

The hydraulic excavator's power, durability, ease of servicing and its precise control increase its effectiveness and life expectancy. With the DX350LC, DOOSAN offers an excellent return on investment.



Multi-function Color LCD Monitor Panel

### Choice of operating modes

- Power Mode :  
use 100% engine power for heavy work, fast speed.
- Standard Mode :  
use 85% engine power for general work, normal speed.
- Economy Mode :  
minimize fuel consumption without less of performance.



### Control lever

Very precise control of the equipment increases versatility, safety and facilitates tricky operations requiring great precision. Levelling operations and the movement of lifted loads in particular are made easier and safer.

The control levers have additional electrical buttons for controlling other additional equipment (for example, grabs, crushers, grippers, etc.)



Rear view camera

### Operation modes

- Mode selection
- Flow rate control
- Auto deceleration
- Display selection
- Rear view camera

### Control panel

With color LCD display

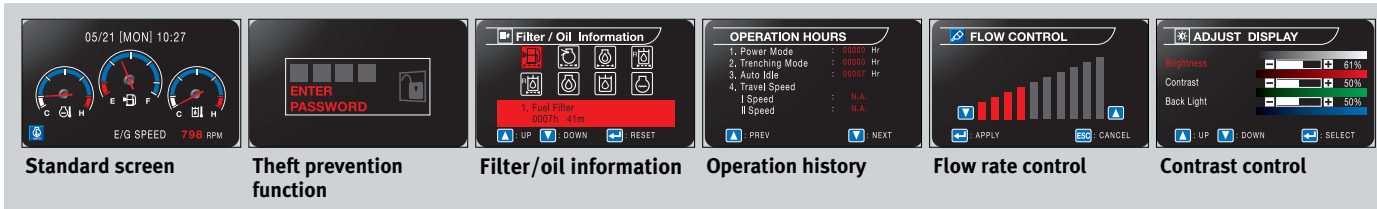

Standard screen

Theft prevention function

Filter/oil information

Operation history

Flow rate control

Contrast control



Cellular phone box



12V Power socket



Cigarette lighter



Glass antenna

The work rate of the hydraulic excavator is directly linked to the performance of its operator. DOOSAN designed the DX350LC by putting the operator at the center of the development goals. The result is significant ergonomic value that improves the efficiency and safety of the operator.

# Comfort

## DX350LC

More space, better visibility, air conditioning, a very comfortable seat... These are all elements that ensure that the operator can work for hours and hours in excellent conditions.



### Control panel

Correct positioning with clear controls makes the operator's task easier.



The high performance air conditioning provides an air flow which is adjusted and electronically controlled for the conditions. Five operating modes enable even the most demanding operator to be satisfied.



### Air suspension seat (Opt.)

Equipped with various functions of adjustment back and forth, and lumbar support, it reduces the vibration of equipment transmitted during work in an effective way. Also for considering winter working environment, Seat warmer functions equipped.



Appropriate storage spaces show the attention given to the operator.



Comfortable 2-stage sliding seat



Control stand (Telescopic Function)



MP3/CD Player (Opt.)



### Audio Button

Audio Button has been positioned in a way that the driver can turn on/off the radio, control the volume, and select a channel conveniently.

# Performance

## DX350LC

The performance of the DX350LC has a direct effect on its productivity. Its new "Common Rail" engine and new e-EPOS controlled hydraulic system have combined to create an unbeatable hydraulic excavator, with a cost/performance ratio that makes the DX340LC even more appealing.



**"COMMON RAIL" DOOSAN DL08 ENGINE**

At the heart of the hydraulic excavator is the new "Common Rail" DOOSAN DL08 engine. It is combined with the new e-EPOS electronic control system, for optimum power and fuel saving.

The new engine produces 271 hp(202 kw/275 PS) at only 1,900 rpm, and more torque, due to its careful design combined with the use of common rail injection and 4 valves per cylinder. These features help optimize combustion and minimize pollution through reduced Nox & particulate emissions.

Increased torque allows efficient use of the power of the hydraulic system.

- Faster working cycles increase productivity.
- Increased torque means the excavator is able to move more easily.
- Energy efficiency reduces fuel consumption.

DOOSAN infracore is aware of the importance of protecting the environment. Ecology was uppermost in the minds of the research workers right from the start of the design of the new machines. The new challenge for the engineers is to combine the protection of nature with equipment performance and to this end DOOSAN has been investing heavily.

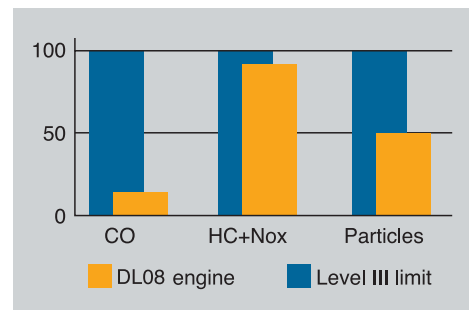
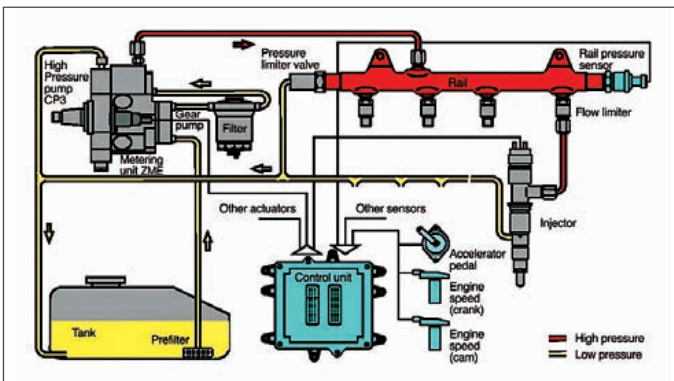

The new DOOSAN engine respects and protects the environment, limiting all types of toxic emissions.



### Hydraulic Pump

The Main pump has a capacity of 2x289 ℓ / min reducing cycle time while a high capacity gear pump improves pilot line efficiency.

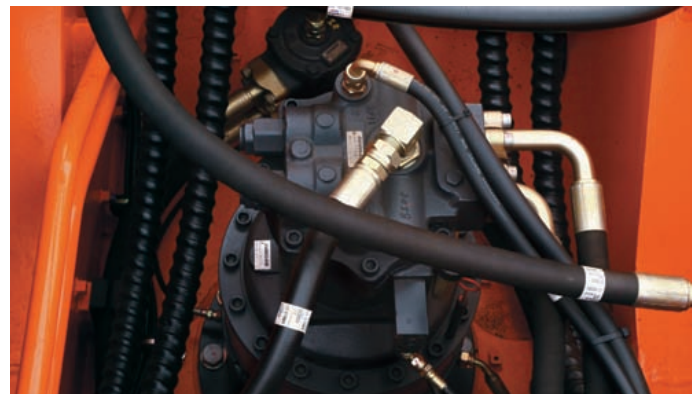

### Swing drive

Shocks during rotation are minimized, while increased torque is available to ensure rapid cycles.

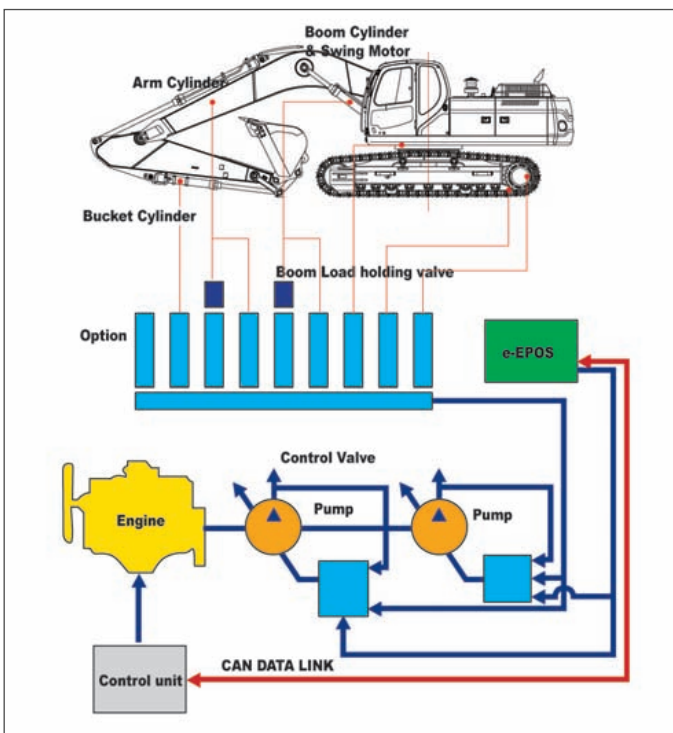

## EXCAVATOR CONTROL

### New e-EPOS system (Electronic Power Optimizing System)

The brains of the hydraulic excavator, the e-EPOS, have been improved and now can electronically link to the engine's ECU (Electronic Control Unit), through a CAN (Controller Area Network) communication link, enabling a continuous exchange of information between the engine and the hydraulic system. These units are now perfectly synchronised.

The advantages of the new e-EPOS impact at several levels, Ease of operation and user-friendliness:

- The availability of a power mode and a normal operating mode guarantee maximum efficiency under all conditions.
- Electronic control of fuel consumption optimizes efficiency.
- The automatic deceleration mode enables fuel saving.
- Regulation and precise control of the flow rate required by the equipment are available as standard.
- A self-diagnosis function enables technical problems to be resolved quickly and efficiently.
- An operational memory provides a graphic display of the status of the machine.
- Maintenance and oil change intervals can be displayed.

# Reliability

DX350LC

The reliability of an item of plant contributes to its overall lifetime operating costs. DOOSAN uses computer-assisted design techniques, highly durable materials and structures then test these under extreme conditions. Durability of materials and longevity of structures are our first priorities.

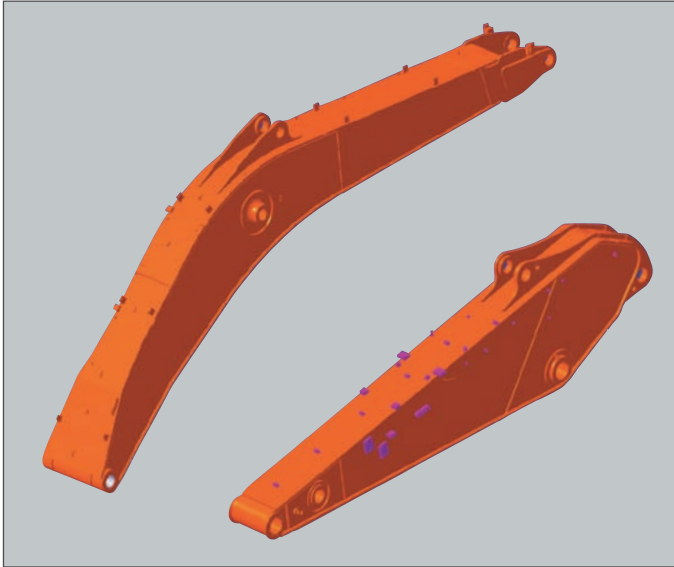

### Strengthened Boom

The shape of the boom has been optimized by finite elements design, allowing uniform load distribution throughout the structure. This combined with increased material thickness means improved durability and reliability by limiting element fatigue.

### Arm Assembly

In the arm assembly greater strength has been gained by using cast elements and reinforcement around the bosses to give it an increased lifetime.

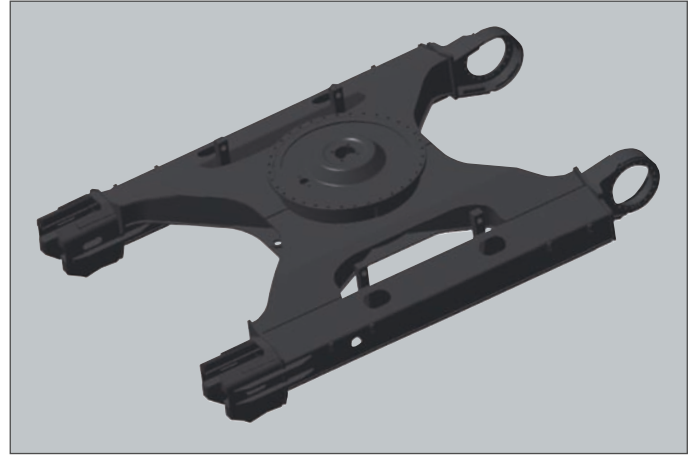

### X-chassis

The X-chassis frame section has been designed using finite element and 3-dimensional computer simulation, to ensure greater durability and optimum structural integrity. The swing gear is solid and stable.

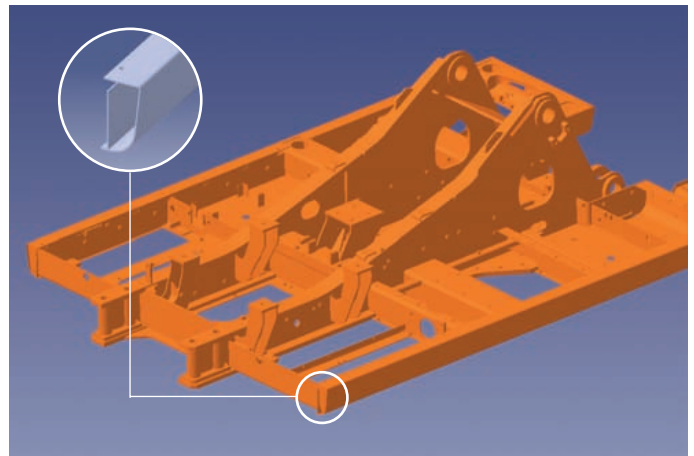

### D-type Frame

The D-type frame design adds strength and minimizes distortion due to shocks.



### Bucket

Highly wear-resistant materials are used for the most susceptible elements such as the blades, teeth, rear and lateral reinforcement plates and corners of the bucket.



### Bushing

A highly lubricated metal is used for the boom pivot in order to increase the lifetime and extend the greasing intervals to 250 hours. A rolled bushing with very fine grooves has been added to the arm bucket pivot; so greasing is only required every 50 hours.



### Ultra-hard wear-resistant disc

New materials have been used in order to increase the wear resistance and to increase the service intervals. The longevity is greatly increased by the addition of wear plates on the inside and outside of the bucket lugs.



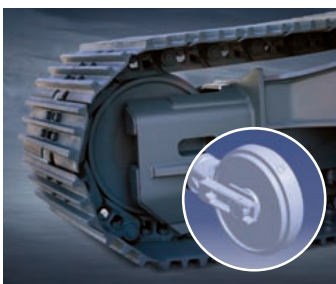

**Integrated Track Spring and Idler**  
The track spring and the idler have been joined directly to achieve high durability and improved maintenance convenience.

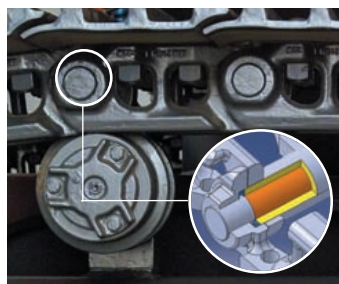

**Tracks**  
The chain is composed of self-lubricating sealed links isolated from all external contamination. The tracks are locked by mechanically bolted pins.



**Polymer shim**  
A polymer shim is added to the bucket pivot to promote extended pin and bushing life.



**Pump coupling**  
A polymer material is used to produce the coupling between the pump and engine. This material has a long life and reduces noise and vibration levels.

# Maintenance

DX350LC

Short maintenance operations at long intervals increase the availability of the equipment on site.

DOOSAN has developed the DX350LC with a view to high profitability for the user.



## Engine oil filter

The engine oil filter offers a high level of filtration allowing the oil change interval to be increased to 500 hours. It is easy to access and is positioned to avoid contaminating the surrounding environment.



## Easy maintenance

Access to the various radiators and coolers is very easy, making cleaning easier. Access to the various parts of the engine is from the top and via side panels.

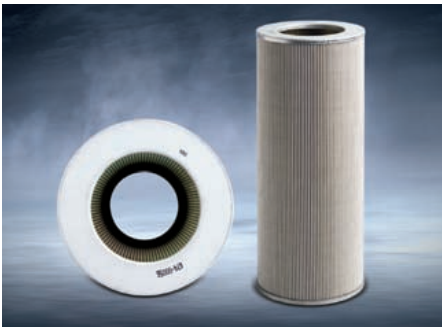

## Hydraulic oil return filter

The protection of the hydraulic system is more effective, using glass fiber filter technology in the main oil return filter. This means that with more than 99.5% of foreign particles filtered out, the oil change interval is increased.



## Air cleaner

The large capacity forced air cleaner removes over 99% of airborne particles, reducing the risk of engine contamination and making the cleaning and cartridge change intervals greater.



## Fuel pre filter with water separator sensor

High efficiency fuel filtration is attained by the use of multiple filters, including a fuel pre-filter fitted with a water separator that removes most moisture from the fuel. Add a warning sensor to a fuel filter for informing when water drain is required.

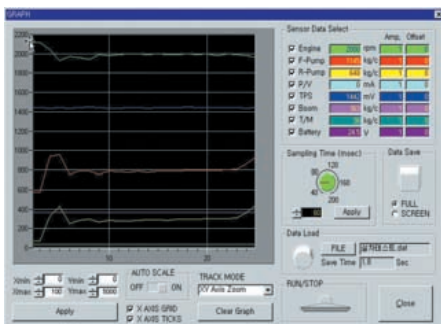

## PC Monitoring (DMS)

A PC monitoring function enables connection to the e-EPOS system, allowing various parameters to be checked during maintenance, such as pump pressures, engine rotation speed, etc. and these can be stored and printed for subsequent analysis.



## Convenient Fuse Box

The fuse box is conveniently located in a section of the storage compartment behind the operator's seat providing a clean environment and easy access.

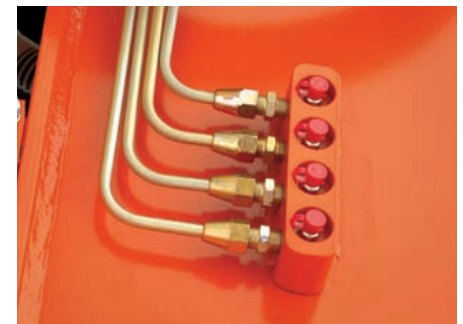

## Centralized grease inlets for easy maintenance

The arm grease inlets are grouped for easy access.



# DX350LC

## Technical specifications

### ENGINE

<b>Model</b>	Doosan DLo8 "Common Rail" engine with direct fuel injection and electronic control, 4 valves per cylinder, vertical injectors, water cooled, turbo charged with air to air intercooler. The emission levels are well below the values required for phase III
<b>Number of cylinders</b>	6
<b>Nominal flywheel power</b>	202 kW (271HP) @ 1,900 rpm (SAE J 1349, net)
<b>Max torque</b>	115 kgf.m (1,128 Nm) / 1,300 rpm
<b>Piston displacement</b>	7,640cc (466.2 cu.in)
<b>Bore &amp; stroke</b>	φ108 mm x 139 mm (4.3" X 5.5")
<b>Starter</b>	24 V x 6.0 kW
<b>Batteries</b>	2 x 12 V / 150 Ah
<b>Air cleaner</b>	Double element and pre-filtered Turbo with auto dust evacuation.

### HYDRAULIC SYSTEM

The heart of the system is the e-EPOS (Electronic Power Optimizing System). It allows the efficiency of the system to be optimized for all working conditions and minimizes fuel consumption.

The new e-EPOS is connected to the engine electronic control via a data transfer link to harmonize the operation of the engine and hydraulics.

- The hydraulic system enables independent or combined operations.
- Two travel speeds offer either increased torque or high speed tracking.
- Cross-sensing pump system for fuel savings.
- Auto deceleration system.
- Two operating modes, two power modes.
- Button control of flow in auxiliary equipment circuits.
- Computer-aided pump power control.

<b>Main pumps</b>	2 variable displacement axial piston pumps max flow: 2 x 289 ℓ /min (2 X 76.3 US gpm, 2 X 63.5 Imp gpm)
<b>Pilot pump</b>	Gear pump - max flow: 21.4 ℓ /min (5.7 US gpm, 4.7 Imp gpm)
<b>Maximum system pressure</b>	Boom/arm/Bucket: 350 kgf/cm <sup>2</sup> (343 bar) Travel: 330 kgf/cm <sup>2</sup> (324 bar) Swing: 270 kgf/cm <sup>2</sup> (265 bar)

### WEIGHT

Boom 6,500 mm (21'4") • Arm 3,200 mm (10'6") • Bucket SAE 1.49 m<sup>3</sup> (1.95 yd<sup>3</sup>)

	<b>Shoe width</b>	<b>Operating weight</b>	<b>Ground pressure (kgf/cm<sup>2</sup>)</b>
Triple Grouser	600 mm (2')	34,500 kg (76,058 lb)	0.66 kgf/cm <sup>2</sup> (65 kpa, 9.4 psi)
	700 mm (2'4")	34,900 kg (76,940 lb)	0.57 kgf/cm <sup>2</sup> (56 kpa, 8.1 psi)
	(Std.) 800 mm (2'8")	35,200 kg (77,603 lb)	0.50 kgf/cm <sup>2</sup> (49 kpa, 7.1 psi)
	850 mm (2'10")	35,400 kg (78,042 lb)	0.48 kgf/cm <sup>2</sup> (47 kpa, 6.8 psi)
	900 mm (2'11")	35,600 kg (78,483 lb)	0.45 kgf/cm <sup>2</sup> (44 kpa, 6.4 psi)
Double Grouser	600 mm (2')	35,200 kg (77,603 lb)	0.67 kgf/cm <sup>2</sup> (66 kpa, 9.5 psi)

## HYDRAULIC CYLINDERS

The piston rods and cylinder bodies are made of high-strength steel. A shock absorbing mechanism is fitted in all cylinders to ensure shock-free operation and extend piston life.

Cylinders	Quantity	Bore X Rod diameter X stroke
Boom	2	150 X 100 X 1,430mm(5.9" X 3.9" X 4'8")
Arm	1	170 X 120 X 1,810mm(6.7" X 4.7" X 5'11")
Bucket	1	150 X 100 X 1,300mm(5.9" X 3.9" X 4'3")

## UNDERCARRIAGE

Chassis are of very robust construction, all welded structures are designed to limit stresses.

High-quality material used for durability.

Lateral chassis welded and rigidly attached to the undercarriage. Track rollers lubricated for life, idlers and sprockets fitted with floating seals.

Tracks shoes made of induction-hardened alloy with double grouser.

Heat-treated connecting pins.

Hydraulic track adjuster with shock-absorbing tension mechanism.

### Number of rollers and track shoes per side

Upper rollers	2 (standard shoes)
Lower rollers	9
Shoes	48
Total length of track	4,940mm (16'2")

## ENVIRONMENT

Noise levels comply with environmental regulations (dynamic values).

<b>LwA External noise</b>	
Guaranteed Sound Power Level	104dB (A) (2000/14/EC)
<b>LpA Operator noise</b>	73dB (A) (ISO 6396)

## BUCKET

Capacity		Width		Weight	Recommendation		
PCSA, heaped	CECE heaped	Without side cutters	With side cutters		2,600mm (8'6") Arm	3,200mm (10'6") Arm (Std.)	3,950mm (12'11") Arm
1.25m <sup>3</sup> (1.63yd <sup>3</sup> )	1.1m <sup>3</sup> (1.44yd <sup>3</sup> )	1,228mm (4')	1,278mm (4'2")	1,236kg (2,725 lb)	A	A	A
1.49m <sup>3</sup> Std.(1.95yd <sup>3</sup> )	1.3m <sup>3</sup> (1.70yd <sup>3</sup> )	1,410mm (4'8")	1,460mm (4'10")	1,345kg (2,965 lb)	A	A	A
1.61m <sup>3</sup> (2.11yd <sup>3</sup> )	1.4m <sup>3</sup> (1.83yd <sup>3</sup> )	1,590mm (4'11")	1,546mm (5'1")	1,394kg (3,073 lb)	A	A	B
1.83m <sup>3</sup> (2.39yd <sup>3</sup> )	1.6m <sup>3</sup> (2.09yd <sup>3</sup> )	1,668mm (5'6")	1,723mm (5'8")	1,524kg (3,360 lb)	A	B	C

A. Suitable for materials with density of 2,000 kg/m<sup>3</sup> (3,370 lb/CU · yd) or less

B. Suitable for materials with density of 1,600 kg/m<sup>3</sup> (2,700 lb/CU · yd) or less

C. Suitable for materials with density of 1,100 kg/m<sup>3</sup> (1,850 lb/CU · yd) or less

## SWING MECHANISM

- An axial piston motor with two-stage planetary reduction gear is used for the swing.
- Increased swing torque reduces swing time.
- Internal induction-hardened gear.
- Internal gear and pinion immersed in lubricant bath.
- The swing brake for parking is activated by spring and released hydraulically.

Swing speed: 0 to 9.6 rpm

## DRIVE

Each track is driven by an independent axial piston motor through a planetary reduction gearbox.

Two levers with control pedals guarantee smooth travel with counter-rotation on demand.

<b>Travel speed (fast/slow)</b>	5.1/3.2 km/h (3.2 /1.9 mph)
<b>Maximum traction force</b>	27,000 kgf (59,525 lbf)
<b>Maximum grade</b>	35° / 70%

## REFILL CAPACITIES

<b>Fuel tank</b>	550 l (145 US gal, 120 Imp gal)
<b>Cooling system (Radiator capacity)</b>	34 l (9.0 US gal, 7.5 Imp gal)
<b>Engine oil</b>	36 l (9.5 US gal, 7.9 Imp gal)
<b>Swing drive</b>	6 l (1.6 US gal, 1.3 Imp gal)
<b>Final drive (each)</b>	5.5 l (1.5 US gal, 1.2 Imp gal)
<b>Hydraulic system</b>	460 l (121.5 US gal, 101.2 Imp gal)
<b>Hydraulic tank</b>	324 l (85.6 US gal, 71.3 Imp gal)

# DX350LC

# Dimensions

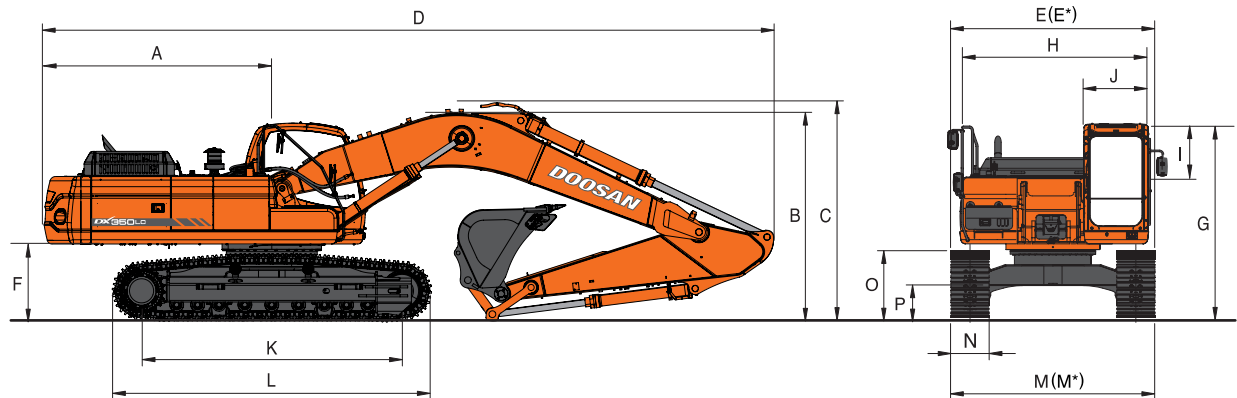

## DIMENSIONS

Boom 6,500 mm (21'4") - Arm 3,200 mm (10'6") - Shoe 800 mm (2'7") - Std

	2,600mm (8'6")	6,500mm (21'4") (Std.) 3,200mm (10'6")	3,950mm (13')
Boom type (One piece)			
Arm type			
Bucket type (pcsa)	1.83m <sup>3</sup>	(Std.) 1.48m <sup>3</sup>	1.25m <sup>3</sup>
A Tail Swing Radius	→	3,500mm (11'6")	←
B Shipping Height (Boom)	3,474mm (11'5")	3,220mm (10'7")	3,355mm (11')
C Shipping Height (Hose)	3,592mm (11'9")	3,360mm (11')	3,483mm (11'5")
D Shipping Length	11,380mm (37'4")	11,280mm (37')	11,300mm (37'1")
E Shipping Width (Std.)	→	3,480mm (11'5")	←
E* Shipping Width (Narrow)	→	3,200mm (10'6")	←
F C/Weight Clearance	→	1,195mm (3'11")	←
G Height Over CAB.	→	3,125mm (10'3")	←
H House Width	→	2,990mm (9'10")	←
I CAB. Height above House	→	845mm (2'9")	←
J CAB. Width	→	1,010mm (3'4")	←
K Tumbler Distance	→	4,040mm (13'3")	←
L Track Length	→	4,940mm (16'2")	←
M Undercarriage Width (Std.)	→	3,480mm (11'5")	←
M* Undercarriage Width (Narrow)	→	3,200mm (10'6")	←
N Shoe Width	→	800mm (2'7")	←
O Track Height	→	1,048mm (3'5")	←
P Car Body Clearance	→	510mm (1'8")	←

## DIGGING FORCE (ISO)

Bucket (PCSA)	1.25m <sup>3</sup>	(Std.) 1.49m <sup>3</sup>	1.61m <sup>3</sup>	1.83m <sup>3</sup>
Digging force			24,500 kg 240 kN 54,012 lbf	
Arm	2,600mm	(Std.) 3,200mm		3,950mm
Digging force	22,000 kgf 216 kN 48,501 lbf		17,900 kgf 176 kN 39,462 lbf	15,100 kgf 148 kN 33,289 lbf

At power boost (ISO)

# DX350LC

## Working range

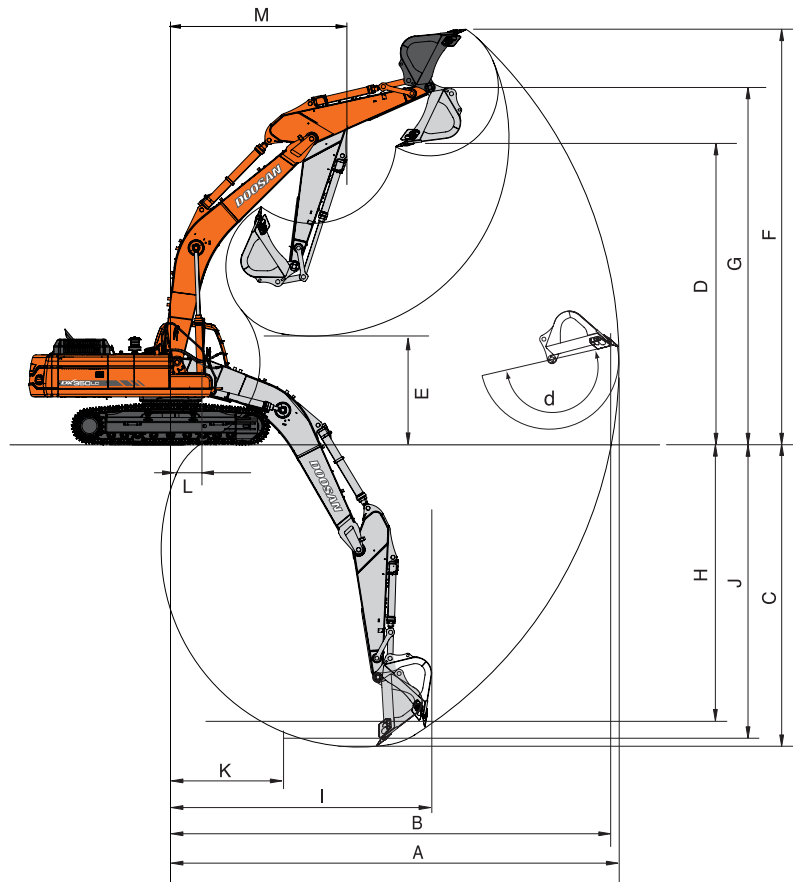

### WORKING RANGE

		(Std.) 6,500mm (21'4")	
Boom length			
Arm type	2,600mm (8'6")	(Std.) 3,200mm (10'6")	3,950mm (13')
Bucket type (pcsa)	1.83m <sup>3</sup>	(Std.) 1.49m <sup>3</sup>	
A. Max. digging reach	10,586 (34'9")	11,168 (36'8")	11,928 (39'2")
B. Max. digging reach at ground level	10,382 (34'1")	10,975 (36')	11,748 (38'7")
C. Max. digging depth	6,931 (22'9")	7,533 (24'7")	8,287 (27'2")
D. Max. dumping height	6,882 (22'7")	7,196 (23'7")	7,661 (25'2")
E. Min. dumping height	3,355 (11')	2,704 (8'10")	1,949 (6'5")
F. Max. digging height	9,994 (32'10")	10,345 (33'11")	10,848 (35'7")
G. Max. bucket pin height	8,584 (28'2")	8,898 (29'2")	9,363 (30'9")
H. Max. vertical wall depth	5,121 (16'10")	5,916 (19'5")	6,858 (22'6")
I. Max. radius vertical	7,711 (25'4")	7,713 (25'4")	7,781 (25'6")
J. Max. digging depth (8' level)	6,719 (22'1")	7,361 (24'2")	8,153 (26'9")
k. Min. radius 8' line	3,345 (10'12")	3,393 (11'2")	3,458 (11'4")
L. Min. digging reach	2,180 (7'2")	723 (2'4")	-325 (-1'8")
M. Min. swing radius	4,438 (14'7")	4,413 (14'6")	4,477 (14'8")
d. Bucket angle (deg)	178°	178°	178°

# DX350LC

# Lifting capacity

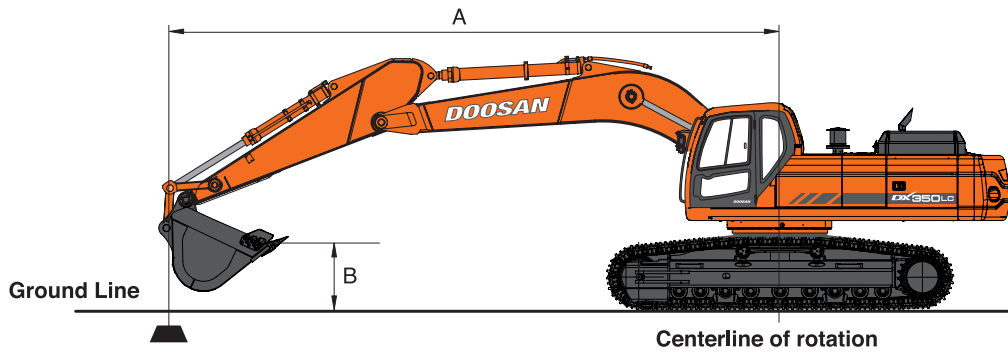

## STANDARD CONFIGURATION

**Metric** Boom : 6,500mm (21'4") Arm : 3,200mm (10'6") Bucket : SAE 1.49m<sup>3</sup> HEAPED (CECE 1.3m<sup>3</sup>) Shoe : 800mm (2'7") Unit : 1,000kg

A(m)	2		3		4		5		6		7		8		9		Max. Reach				
																			A(m)		
8																			*6.05	*6.05	7.48
7														*6.61	6.28				*6.07	6.01	8.19
6												*6.91	*6.91	*6.75	6.22				*6.18	5.31	8.73
5												*7.45	*7.45	*7.06	6.12	*6.82	4.96		*6.39	4.84	9.12
4							*10.50	*10.50	*9.07	*9.07	*8.13	7.47	*7.50	5.99	*7.06	4.89		*6.69	4.53	9.39	
3			*9.78	*9.78	*16.01	*16.01	*12.29	12.28	*10.20	9.24	*8.88	7.25	*7.98	5.84	*7.36	4.79		6.67	4.32	9.55	
2					*18.56	16.66	*13.91	11.77	*11.27	8.92	*9.60	7.04	*8.47	5.70	7.26	4.70		6.54	4.22	9.59	
1			*6.05	*6.05	*17.11	16.13	*15.11	11.39	*12.14	8.65	*10.22	6.85	8.64	5.57	7.17	4.62		6.54	4.20	9.53	
O (Ground)			*8.88	*8.88	*17.23	15.88	*15.80	11.14	*12.73	8.46	10.53	6.71	8.53	5.47	7.10	4.55		6.67	4.27	9.37	
-1	*8.82	*8.82	*12.08	*12.08	*19.46	15.79	*16.00	11.01	*12.99	8.34	10.42	6.61	8.46	5.40	7.06	4.51		6.96	4.45	9.08	
-2	*12.26	*12.26	*15.66	*15.66	*19.78	15.80	*15.76	10.97	*12.91	8.29	10.37	6.57	8.43	5.38				7.45	4.76	8.68	
-3	*15.86	*15.86	*19.78	*19.78	*18.69	15.89	*15.10	11.01	*12.45	8.30	10.38	6.58	8.45	5.40				8.26	5.28	8.12	
-4	*19.89	*19.89	*21.45	*21.45	*17.07	16.06	*13.93	11.11	*11.52	8.37	*9.54	6.65						*8.81	6.14	7.39	
-5	*23.71	*23.71	*18.23	*18.23	*14.74	*14.74	*12.10	11.29	*9.90	8.53								*9.03	7.71	6.42	
-6					*11.29	*11.29	*9.12	*9.12											*8.98	*8.98	5.07

## Feet

Unit : 1,000lb

A(ft)	10'		15'		20'		25'		30'		Max. Reach				
													A(ft)		
25							*14.49	*14.49					*13.32	*13.32	25.51
20							*14.92	*14.92					*13.60	11.83	28.49
15					*18.44	*18.44	*16.32	14.53	*15.17	10.57			*14.34	10.34	30.35
10	*25.56	*25.56	*29.74	*29.74	*22.03	19.90	*18.21	13.97	15.82	10.29			14.73	9.55	31.30
5	*12.05	*12.05	*35.89	29.25	*25.37	18.90	*20.06	13.42	15.51	10.00			14.39	9.26	31.42
O (Ground)	*20.18	*20.18	*38.74	28.22	*27.54	18.20	20.30	13.00	15.27	9.78			14.71	9.42	30.73
-5	*31.18	*31.18	*38.67	27.90	*28.13	17.87	20.06	12.77					15.85	10.13	29.16
-10	*44.69	*44.69	*36.25	28.03	*26.90	17.86	20.07	12.79					18.33	11.71	26.55
-15	*43.01	*43.01	*31.12	28.53	*23.17	18.18							*19.73	15.23	22.54
-20			*21.27	*21.27									*19.70	*19.70	16.09

1. Ratings are based on SAE J1097
2. The load point is a hook located on the back of the bucket.
3. \* Rated loads are based on hydraulic capacity.
4. Rated loads do not exceed 87% of hydraulic capacity or 75% of tipping capacity.

: Rating Over Front  
 : Rating Over Side or 360 degree



## Option 1

### Metric

















Boom : 6,500mm (21'4")

Arm : 2,600mm (8'6")

Bucket : SAE 1.83m<sup>3</sup> HEAPED (CECE 1.6m<sup>3</sup>)













Shoe : 800mm (2'7")

Unit : 1,000kg

A(m)	2		3		4		5		6		7		8		Max. Reach			
																		A(m)
8												*7.09	*7.09			*7.10	*7.10	7.02
7												*7.09	*7.09			*7.08	6.52	7.77
6												*7.40	*7.40	*7.17	6.15	*7.13	5.71	8.34
5									*8.62	*8.62	*7.92	7.62	*7.44	6.07	*7.22	5.17	8.75	
4					*14.25	*14.25	*11.32	*11.32	*9.64	9.50	*8.56	7.42	*7.84	5.95	*7.35	4.82	9.03	
3					*17.26	17.16	*13.03	12.13	*10.71	9.16	*9.26	7.21	*8.29	5.81	7.09	4.60	9.19	
2					*16.12	*16.12	*14.50	11.64	*11.69	8.85	*9.92	7.00	*8.72	5.68	6.95	4.49	9.24	
1					*14.35	*14.35	*15.49	11.29	*12.45	8.60	*10.46	6.83	8.64	5.57	6.96	4.47	9.18	
O(Ground)					*16.26	15.78	*15.95	11.09	*12.90	8.43	10.52	6.70	8.54	5.48	7.12	4.56	9.00	
-1			*12.17	*12.17	*19.91	15.76	*15.95	11.00	*13.02	8.34	10.44	6.63	8.49	5.43	7.46	4.78	8.17	
-2	*13.37	*13.37	*16.92	*16.92	*19.21	15.83	*15.52	11.00	*12.79	8.32	10.42	6.61	8.48	5.42	8.05	5.15	8.28	
-3	*17.99	*17.99	*22.27	*22.27	*17.92	15.97	*14.67	11.07	*12.16	8.36	*10.16	6.64			*8.92	5.78	7.70	
-4	*23.28	*23.28	*19.74	*19.74	*16.08	*16.08	*13.28	11.21	*11.01	8.47					*9.15	6.86	6.92	
-5			*16.24	*16.24	*13.43	*13.43	*11.11	*11.11							*9.23	8.97	5.87	

### Feet

Unit : 1,000lb

A(ft)	10'		15'		20'		25'		30'		Max. Reach			
														A(ft)
25												*15.61	*15.61	24.05
20							*15.89	14.81				*15.70	12.72	27.19
15					*19.71	*19.71	*17.19	14.42				*16.04	11.03	29.14
10			*31.75	30.77	*23.14	19.74	*18.94	13.89	15.76	10.23		15.65	10.15	30.13
5			*37.12	28.89	*26.17	18.78	*20.60	13.38	15.50	9.99		15.29	9.85	30.25
O(Ground)			*38.98	28.06	*27.92	18.16	20.32	13.01				15.69	10.06	29.53
-5	*32.76	*32.76	*38.12	27.91	*28.04	17.91	20.14	12.84				17.05	10.91	27.89
-10	*48.33	*48.33	*35.03	28.17	*26.26	18.00	*19.87	12.95				*19.69	12.84	25.15
-15	*39.03	*39.03	*29.07	28.84	*21.57	18.46						*20.33	17.34	20.87

1. Ratings are based on SAE J1097
2. The load point is a hook located on the back of the bucket.
3. \* Rated loads are based on hydraulic capacity.
4. Rated loads do not exceed 87% of hydraulic capacity or 75% of tipping capacity.



: Rating Over Front



: Rating Over Side or 360 degree

# DX350LC

# Lifting capacity

## Option 2

### Metric

Boom : 6,500mm (21'4")

Arm : 3,950mm (13')

Bucket : SAE 1.25m<sup>3</sup> HEAPED (CECE 1.1m<sup>3</sup>)

Shoe : 800mm (2'7")

Unit : 1,000kg

A(m) B(m)	2		3		4		5		6		7		8		9		10		Max. Reach		A(m)			
8																					*4.43	*4.43	8.76	
7																*5.39	5.32					*4.41	*4.41	9.37
6														*5.94	*5.94	*5.95	5.28					*4.45	*4.45	9.84
5														*6.33	*6.33	*6.18	5.21	*5.22	4.29			*4.54	4.13	10.19
4											*7.27	*7.27	*6.83	6.25	*6.50	5.11	*6.21	4.23			*4.69	3.91	10.43	
3								*10.65	*10.65	*9.11	*9.11	*8.10	7.55	*7.39	6.09	*6.88	5.00	6.36	4.16			*4.89	3.76	10.57
2			*12.01	*12.01	*16.30	*16.30	*12.52	12.29	*10.33	9.28	*8.93	7.31	*7.97	5.92	*7.28	4.89	6.28	4.08			*5.16	3.67	10.61	
1			*8.54	*8.54	*18.62	16.71	*14.10	11.79	*11.43	8.95	*9.70	7.09	*8.51	5.76	7.34	4.78	6.20	4.01			*5.50	3.66	10.56	
0 (Ground)	*4.85	*4.85	*8.99	*8.99	*18.20	16.21	*15.23	11.43	*12.28	8.69	*10.32	6.90	8.70	5.63	7.24	4.68	6.13	3.95			5.76	3.70	10.41	
-1	*7.15	*7.15	*10.68	*10.68	*18.18	15.95	*15.87	11.19	*12.83	8.50	10.57	6.76	8.59	5.53	7.16	4.61	6.09	3.91			5.95	3.82	10.15	
-2	*9.60	*9.60	*13.01	*13.01	*19.98	15.84	*16.07	11.07	*13.07	8.39	10.47	6.67	8.52	5.46	7.12	4.57					6.27	4.02	9.79	
-3	*12.28	*12.28	*15.89	*15.89	*19.96	15.84	*15.82	11.03	*12.96	8.34	10.43	6.63	8.49	5.44	7.11	4.57					6.77	4.35	9.31	
-4	*15.30	*15.30	*19.41	*19.41	*18.88	15.93	*15.13	11.07	*12.46	8.36	*10.43	6.64	8.51	5.46							7.55	4.86	8.68	
-5	*18.83	*18.83	*22.05	*22.05	*17.20	16.10	*13.92	11.18	*11.48	8.44	*9.52	6.72									*7.96	5.68	7.87	
-6	*23.17	*23.17	*18.60	*18.60	*14.73	*14.73	*11.98	11.37	*9.77	8.61											*8.10	7.15	6.82	
-7					*11.04	*11.04	*8.81	*8.81														*7.99	*7.99	5.38

### Feet

Unit : 1,000lb

A(ft) B(ft)	10'		15'		20'		25'		30'		Max. Reach		A(ft)				
25													*9.72	*9.72	29.55		
20													*13.09	11.32	*9.79	*9.79	32.15
15								*14.63	*14.63	*13.85	11.08		*10.13	8.87			33.80
10				*25.29	*25.29	*19.70	*19.70	*16.75	14.55	*15.00	10.74		*10.75	8.29			34.66
5	*22.03	*22.03	*32.67	30.48	*23.58	19.61	*18.96	13.91	15.90	10.38			*11.71	8.06			34.77
0 (Ground)	*20.47	*20.47	*37.43	28.91	*26.58	18.71	20.70	13.37	15.57	10.07			12.70	8.16			34.14
-5	*26.60	*26.60	*39.14	28.18	*28.13	18.16	20.31	13.02	15.35	9.87			13.44	8.62			32.74
-10	*35.89	*35.89	*38.29	28.02	*28.03	17.96	20.16	12.88	15.32	9.84			14.99	9.63			30.45
-15	*48.75	*48.75	*34.95	28.28	*25.92	18.08	*19.65	13.00					*17.35	11.63			27.04
-20	*39.64	*39.64	*28.24	*28.24	*20.62	18.58							*17.88	16.20			21.98

1. Ratings are based on SAE J1097
2. The load point is a hook located on the back of the bucket.
3. \* Rated loads are based on hydraulic capacity.
4. Rated loads do not exceed 87% of hydraulic capacity or 75% of tipping capacity.



: Rating Over Front



: Rating Over Side or 360 degree

## STANDARD EQUIPMENT

### Hydraulic system

- Boom and arm flow regeneration
- Boom and arm holding valves
- Swing anti-rebound valves
- Spare ports(valve)

### Cabin & Interior

- Viscous cab mounts
- All weather sound suppressed type cab
- Air conditioner
- Adjustable suspension seat with head rest and adjustable arm rest
- Pull-up type front window and removable lower front window
- Room light
- Intermittent windshield wiper
- Cigarette lighter and ashtray
- Cup holder
- Hot & Cool box
- 7" LCD color monitor panel
- Fuel control dial
- AM/FM radio and cassette player
- Remote radio ON/OFF switch
- 12V spare powers socket
- Serial communication port for laptop PC interface
- Joystick lever with 3 switches
- Sunvisor
- Sun roof

### Safety

- Large handrails and step
- Punched metal anti-slip plates
- Seat belt
- Hydraulic safety lock lever
- Safety glass
- Hammer for emergency escape
- Right and left rearview mirrors
- Travel alarm

### Others

- Double element air cleaner
- Pre-cleaner
- Fuel pre filter with water separator sensor
- Dust screen for radiator/oil cooler
- Engine overheat prevention system
- Engine restart prevention system
- Self-diagnostic system
- Alternator (24V, 50 amps)
- Electric horn
- Halogen working lights (frame mounted 2, boom mounted 2)
- Hydraulic track adjuster
- Track guards
- Double fuel filter
- Greased and sealed track link
- Hydraulic oil tank air breather filter

## OPTIONAL EQUIPMENT

Some of these optional equipment may be standard in some markets. Some of the optional equipment may not be available in some markets. You must check with the local DOOSAN dealer to learn about the availability or to release the adaptation following the needs of the applications.

### Safety

- Boom and arm hose rupture protection valve
- Overload warning device
- Cabin Top/Front guard (ISO 10262, FOGS standard)
- Travel & swing alarm
- Rotation beacon
- Rear view camera

### Cabin & Interior

- Air suspension seat
- MP3/CD player

### Others

- Piping for crusher
- Piping for quick clamp
- Breaker filter
- 700mm/800mm/850mm/900mm shoe
- Full track guards
- Lower wiper
- Fuel heater
- Double grouser shoe



**Seoul Office :**  
Doosan Tower 27<sup>th</sup> FL. 18-12, Euljiro-6 Ga,  
Jung-Gu, Seoul, Korea 100-730  
Tel : +82-2-3398-8049  
Fax : +82-2-3398-8117  
[www.doosaninfracore.com](http://www.doosaninfracore.com)

**Doosan Infracore Europe S.A.**  
1A, Rue Achille Degrace, 7080 Frameries, Belgium  
Tel : +32-65-61-3230 Fax : +32-65-67-7338

**Doosan Infracore U.K., Ltd.**  
Doosan House, Unit 6, 3 Heol Y Gamlas, Parc Nantgarw, Nantgarw,  
Cardiff. CF15 7QU, U.K.  
Tel : +44-1443-84-2273 Fax : +44-1443-84-1933

**Doosan Infracore Europe S.A. Germy**  
Heinrich-von- Stephan str. 2 40764 Langenfeld, Germany  
Tel : +49-2173-2035-210 Fax : +49-2173-2035-219

**Doosan Infracore France**  
ZAC de La Clef Saint Pierre - Buroplus 2 1A Avenue Jean d'Alembert  
78990 Elancourt, France  
Tel : +33-(0)1-30-16-21-41 Fax : +33-(0)1-30-16-21-44

**Doosan Infracore America Corporation**  
2905 Shawnee Industrial Way, Suwanee, Georgia 30024, U. S. A  
Tel : +1-770-831-2200 Fax : +1-770-831-0480

**Doosan Infracore China Co., Ltd.**  
#28, Wuzhishan Road, Eco. & Tech, Development Zone, Yantai, Shandong, China  
Tel : +86-535-638-2000 Fax : +86-535-638-2004

**Doosan Infracore Russia**  
123242, Moscow, Kapranova Lane, bld.3, office 402, 4-th floor  
Business Centre "Premier Plaza"  
Tel : +7 (495)663 82 38/ (499) 923 12 55 Fax: +7 (495) 663 82 39

**Doosan Infracore Middle East Center (Dubai)**  
P.O.Box 183127, Al-Serkal Building, Air Port Road, Dubai, U.A.E  
Tel : +971-4-295-2781~2 Fax :+971-4-295-2783

**Doosan Infracore do Brasil Serviços de Suporte Comercial Ltda.**  
Alameda Santos 2222 Cj52 CEP 01418.200 São Paulo, SP, Brasil  
Tel : +55-11-3061-3227 Fax : +55-11-3061-2731

**Doosan Infracore India Pvt.Ltd**  
Plot No. 34, Door No. 1/61-19, Palwels street, Ravi Colony,  
St. Thomas Mount, Chennai-600 016  
Tel : +91-44-4222-3900 Fax : +91-44-4222-3905



PBP D350C000 0810

The illustrations do not necessary show the product in standard version.  
All products and equipment are not available in all markets.  
Materials and specifications are subject to change without prior notice.